

2003

INTERNATIONAL MIRROR CLASS RULES

Authority*: International Sailing Federation



I S A F

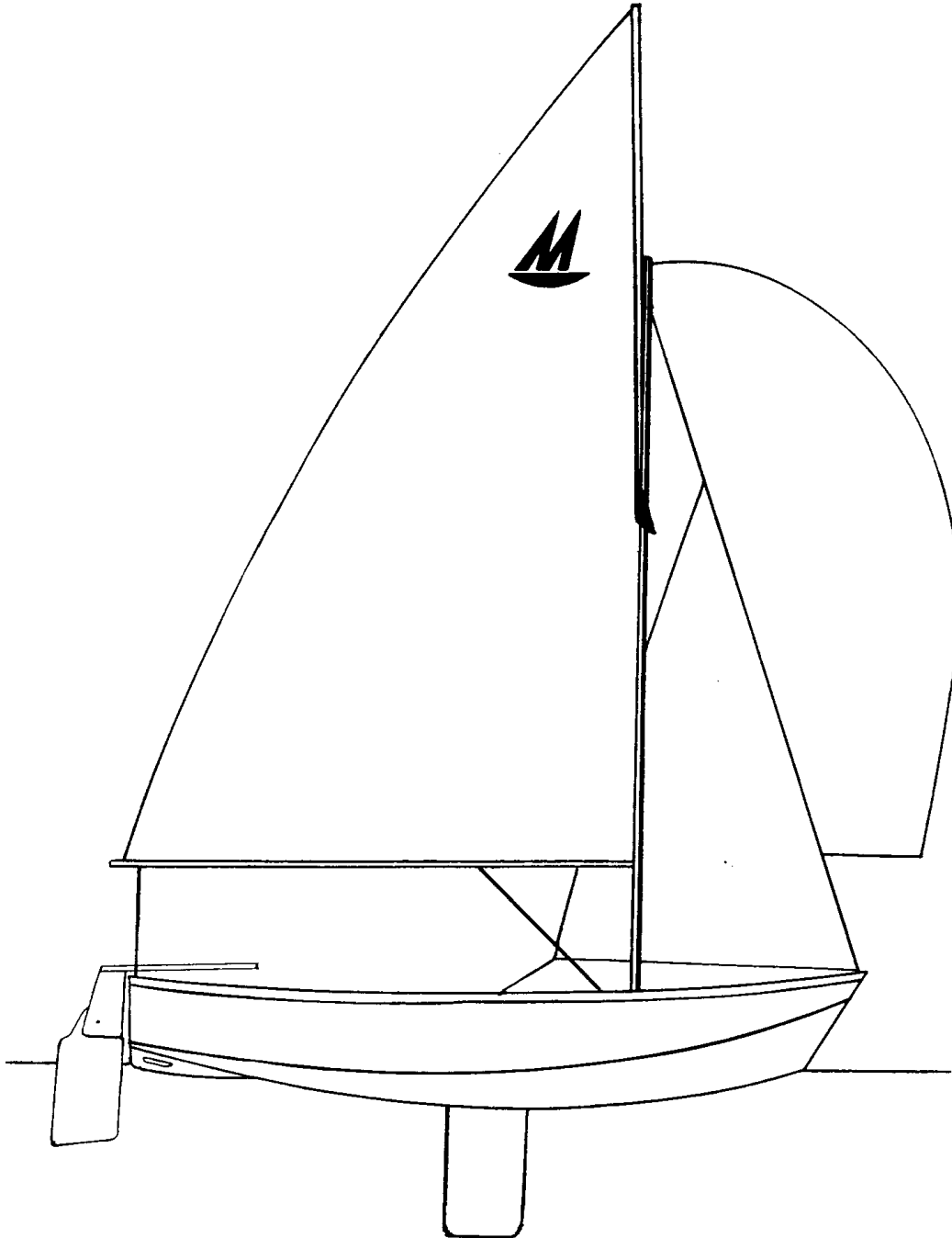

* The International Sailing Federation (ISAF) is not a National Authority (NA).

PART A - ADMINISTRATIVE RULES

1. GENERAL

- 1.1 The Mirror is a One-Design Class Dinghy. The objective of the Class Rules is to ensure that Mirror Class dinghies are as nearly alike as possible with regard to any matter which may have influence on the basic speed or handling.
- 1.2 Whenever the words "Class Rules" are used, unless stated otherwise, they shall be taken as including these rules and diagrams, the approved plans and specification, and the Measurement Form.
- 1.3 All Mirror Class dinghies shall be built and measured in accordance with the Class Rules and no alterations or additions are permitted unless specifically stated.
- 1.4 If the measurer considers that there has been any attempt to depart from the design or the Class Rules in any particular, he shall report the matter to the National Authority or the International Mirror Class Association who shall consult the ISAF.
- 1.5 In the event of a discrepancy between these rules and the Measurement Form, the matter shall be referred to the ISAF.

2. AUTHORITY

- 2.1 The authority for the class shall be the ISAF which shall co-operate with the International Mirror Class Association in all matters regarding these rules.
- 2.2 Any questions regarding these Rules shall be addressed to a National Mirror Class Association. In countries where there is no National Mirror Class Association questions may be put directly to the National Authority or the International Mirror Class Association.
- 2.3 Interpretation of these rules shall be made by the ISAF which shall consult the International Mirror Class Association. All such interpretations shall be submitted by 31st December next, to the IMCA membership for consideration of their incorporation into these Rules in accordance with the provisions of the IMCA Constitution.
- 2.4 The administering authority is the National Authority of the country of the owner. In countries where there is no National Authority or the National Authority does not wish to administer the class, its functions as stated in these rules shall be carried out by the International Mirror Class Association or its delegated representatives (National Mirror Class Associations).
- 2.5 Neither the ISAF, the International Mirror Class Association, a National Authority nor any National Mirror Class Association or approved measurer are under any legal responsibility in respect of these rules or accuracy of measurement and no claim arising from them can be entertained.
- 2.6 The official language of the class is English and in the event of dispute over translation, the English text shall prevail.
- 2.7 The word "shall" is mandatory and the word "may" is permissive.

3. BUILDER

- 3.1 The Mirror Class dinghy shall be built only by Kit Manufacturers, GRP Builders, and Professional Builders or Amateur Builders. For the purpose of these rules an Amateur Builder is one who builds not more than one Mirror Class Dinghy in any year.
- 3.2 New kit Manufacturers, GRP Builders and Professional Builders shall be licensed by ISAF (Jersey) Ltd. Licences may be issued after consultation with the National Authority and the National Mirror Class Association or International Mirror Class Association.
- 3.3 Licensed Kit Manufacturers shall be entitled to build Mirror Kits complying with the ISAF approved specification or complete Mirror dinghies.
- 3.4 Amateur or Professional Builders shall construct Mirrors only from kits supplied by Licensed Kit Manufacturers.
- 3.5 Only licensed GRP Builders shall build GRP Mirrors.
- 3.6 Kit Manufacturers, GRP Builders and Professional Builders shall be responsible for supplying complete boats complying with the Class Rules. The Builder shall, at his own expense, correct or replace any boat that does not comply with the Class Rules as a result of an omission or error by the builder, provided that the boat is submitted for measurement within twelve months of purchase.

4. INTERNATIONAL CLASS FEE

- 4.1 The International Class Fee shall be paid by the Licensed Kit Manufacturer or GRP Builder on each hull as building commences or before each kit or GRP Mirror leaves the premises, whether or not the kit is subsequently completed by that manufacturer or another builder, and whether or not it is subsequently measured and registered.
- 4.2 The Kit Manufacturer or GRP Builder shall receive the ISAF Plaque (which serves as the International Class Fee Receipt) through Sailing International Ltd, Ariadne House, Town Quay, Southampton, SO14 2AQ, United Kingdom. The Plaque shall have on it the sail number for the dinghy and be fixed onto the inside face of the aft transom by the builder upon completion of construction. Only boats above sail number 69070 will be required to display an ISAF Plaque. Boats below number 69070 shall use the sail number on the Measurement Form.
- 4.3 The amount of the International Class Fee may be reviewed by the ISAF.

5. MEASUREMENT CERTIFICATE

- 5.1 A Measurement Certificate is either:-
 - a) an original, or certified true copy, of the Measurement Form which has been stamped by the National Authority or the National Mirror Class Association, or
 - b) A document in a form approved for this purpose by the ISAF and issued by the National Authority or the National Mirror Class Association
- 5.2 To obtain a Measurement Certificate the owner shall arrange for an approved measurer to measure the boat and to check that the weight correctors, if any, are fitted. After the Measurement Form has been properly completed and signed by the measurer and the owner

it shall be sent to the National Authority or the National Mirror Class Association who shall check and stamp the form and issue the Measurement Certificate.

- 5.3 The Measurement Certificate is only valid when the owner is a current member of a National Mirror Class Association or, when there is no National Association in his nation, a member of the International Mirror Class Association.
- 5.4 Change of ownership invalidates the Measurement Certificate. The new owner shall return the original certificate to his National Authority or National Mirror Class Association who shall then re-validate it or issue a replacement Measurement Certificate.

6. ENDORSEMENTS

- 6.1 Before a boat is eligible to race the Measurement Certificate must have endorsements for-
- (i) Buoyancy - The initial buoyancy test or inspection shall be carried out in accordance with Rule 4 by a measurer approved under Administrative Rule 7. Subsequently annual buoyancy tests or inspections are required but these may be carried out either by a measurer or by any properly appointed Club Officer. Upon satisfactory completion of a buoyancy test or inspection under this Rule the measurer or Club Officer shall sign and date the buoyancy section of the Measurement Certificate.
 - (ii) Sails - The owner shall have all sails to be used for racing measured in accordance with the Class Rules. On completion of satisfactory measurement the measurer shall sign and date the sail at its tack.
 - (iii) Weight - The boat shall be weighed in accordance with the Class Rules and on satisfactory completion the measurer will sign and date the weight endorsement section of the Measurement Certificate. Corrector weights shall not be removed or changed without the dinghy being officially re-weighed and the Measurement Certificate endorsed.

7. MEASUREMENT

- 7.1 Only a measurer approved by the National Authority, National Mirror Class Association or the International Mirror Class Association shall measure a boat, her spars, sails and equipment and sign the declaration on the Measurement Form that they comply with the Class Rules.
- 7.2 Measurements shall be taken in accordance with the ISAF Equipment Rules of Sailing for 1997-2000 unless otherwise specified in these rules.
- 7.3 A measurer shall not measure a boat, spars, sails or equipment owned, designed or built by the measurer, or in which the measurer is an interested party, or has a vested interest.
- 7.4 All boats, spars, sails and equipment shall be liable to re-measurement at the discretion of a National Authority or Race Committee, but only by an approved measurer.
- 7.5 Alterations, replacements or repairs to all boats shall comply with the current Class Rules and where the replacement of hull panels is required, shall be carried out using only such panels originally supplied by a licensed kit manufacturer. Part B, Rule 1.1.2 shall apply to any modification of parts used for alteration, replacement or repair. If a boat has been repaired or re-built to an extent which exceeds one third of the hull it shall be re-measured in accordance with the current Class Rules.

- 7.6 All boats, spars, sails and equipment shall comply with the current Class Rules and relevant Racing Rules of Sailing at all times unless otherwise specified in these rules.
- 7.7 Notwithstanding anything contained herein, the National Authority has the right to refuse to grant or withdraw a Measurement Certificate and/or endorsements. Owners are to return their Measurement Certificates to the National Authority or National Mirror Class Association upon request.

PART B - MEASUREMENT RULES

1. HULL

1.1 Construction Materials

- 1.1.1 The Licensed Kit Manufacturer shall complete hulls using only wood, plywood, glassfibre tape, resin and adhesives to the ISAF specification.
- 1.1.2 Amateur and Professional Builders shall complete hulls using only materials supplied with the Mirror kits (except for adhesives which are optional) and shall not modify or replace any part of the kit except where specifically permitted by these Rules.
- 1.1.3 GRP Builders shall complete hulls using only materials prescribed in the ISAF GRP Building Specification.
- 1.1.4 Finishes are optional but they shall not be reinforced except where permitted in these rules.

1.2 Construction

- 1.2.1 All the panels and wood parts supplied with the kit shall be incorporated into the hull with the exception of the forward shroud blocks, jib fairleads and forward mast step which are optional. All wood parts shall be used only for their intended purpose. Where these Rules provide that the material of a part is optional the supplied wood part may be replaced by an equivalent part of the alternative material.
- 1.2.2 The shell of the wooden hulls shall be constructed using the 'stitch and glue' method of construction and all hull joints so constructed shall be reinforced with at least one layer of the glass fibre tape supplied with the kit on both the inside and the outside of the joint. Joints between other kit panels, shall be reinforced with at least one layer of the glass fibre tape supplied with the kit.
- 1.2.3 GRP hulls shall be constructed in accordance with the ISAF GRP Building Specification.

1.3 Measurement Definitions

- 1.3.1 Chine - The chine is defined by the intersection of the extensions of the outside faces of the bottom and side panels, and shall be fair.
- 1.3.2 Not in use.
- 1.3.3 Not in use.
- 1.3.4 Forward Measurement Point - The Forward Measurement Point is defined by the intersection of the outside surface of the keelband on the centreline and the extension of the face of the bow transom.
- 1.3.5 Measurement Sections - The Measurement Sections shall be defined by the following points measured from the aft face of the aft transom along the hull centrelines, chines and sheerlines immediately below the outer gunwales.

SECTION	HULL CENTRELINE mm	CHINE mm	SHEERLINE mm
0	0	0	0
1	700	700	705
2	1400	1400	1400
3	2135	2140	2135
4	2460	2470	2465

1.4 **Hull Shape**

1.4.1 The distance from the base line conforming with the diagram to the keelband on the centreline shall be within $\pm 10\text{mm}$ of the measurements below measured perpendicular to the base line:

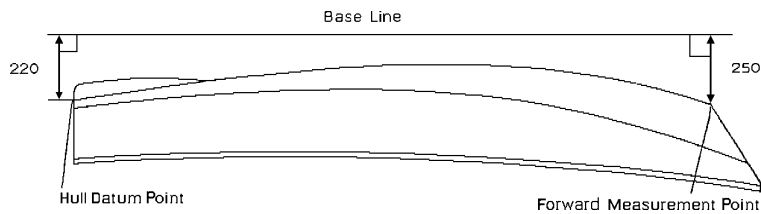

SECTION	mm
1	108
2	38
3	44
4	76

1.4.2 No point on the centreline of the aft face of the aft transom shall be more than 10mm from a line through the Hull Datum Point, perpendicular to the base line.

1.4.3 The hull sections shall conform with the diagram and table below where:

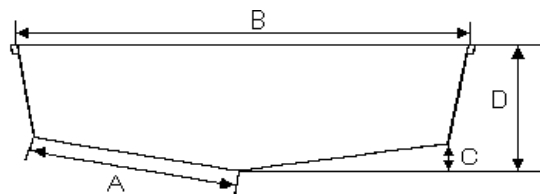

- A is the width of each bottom panel from the hull centreline to the chine.
- B is the beam at the sheerline.

- C is the distance from a horizontal line touching the keelband to the chine, except for section 0 where the horizontal line shall pass through the Hull Datum Point.
- D is the distance from a horizontal line touching the keelband to the sheerline except for section 0 where the horizontal line shall pass through the Hull Datum Point.

SECTION	A mm	B mm	C mm	D mm
0	480	1063	60	312
1	578	1284	70	418
2	614	1382	120	499
3	595	1296	203	525
4	563	1172	240	520

Measurement A at each section, tolerance = ± 8 mm

Measurement C at Section 0, tolerance = ± 8 mm

Measurement B at each section (except section 0) tolerance = ± 20 mm

Measurement D at each section (except section 0) tolerance = ± 15 mm

All other measurements, tolerance = ± 10 mm

- 1.4.4 The distance measured around the outside of the hull shell adjacent to the keelband, from the Forward Measurement Point to the Hull Datum Point shall be 3088mm ± 10 mm.
- 1.4.5 The distance from the centre of the top of the bow shapes in line with the bow transom to the Forward Measurement Point measured along the face of the bow transom shall be 520mm ± 10 mm.
- 1.4.6 The minimum beam of the bow transom measured along or parallel to the face of the transom shall conform to the following table.

DISTANCE FROM FORWARD MEASUREMENT POINT	BEAM
275 mm	405 mm
475 mm	550 mm

Boats with sail numbers lower than 69931 and constructed and certified on or before June 30 1998 shall have a beam at the top measurement point of not less than 500mm.

- 1.4.7 The athwartships curvature of the bottom panels between points set 50mm inboard from the chine and 50mm outboard from the centreline shall conform with the table (positive for convex curve).

SECTION	CURVATURE
0	6mm ± 3mm
1	0mm ± 3mm
2	8mm ± 5mm
3	8mm ± 5mm

1.4.8 Between sections 0 and 3, the radius of the chines shall be not more than 10mm.

1.4.9 The bilge keels shall conform with the diagram. They shall be not less than 13mm in width and not less than 9mm depth for a length of not less than 915mm.

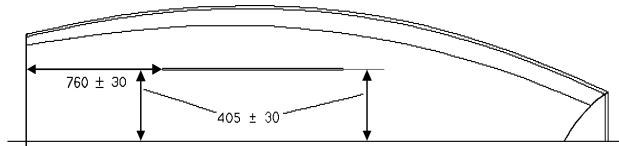

1.4.10 The skeg shall conform with the diagram. The dimensions shall include the keelband. The overall length shall be not less than 635mm and the thickness at the hull not less than 18mm. The hole in the skeg shall be 142mm ± 10mm long and 23mm ± 5mm deep. The hole may be faired to a distance not more than 25mm from the inside edge. The aft edge of the hole shall be 200mm +/- 15mm forward of the Aft Measurement Point. The hole shall be 15mm +/- 5mm from the hull surface.

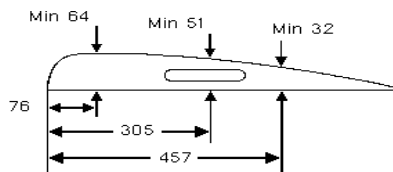

1.4.11 The centreboard case shall conform with the diagram. The height of the centreboard case shall be measured from the underside of the outside hull shell, including keelbands, at the aft and forward edges of the centreboard slot. Except for the first 5mm at each end, the width of the centreboard slot shall be 15mm +/- 4mm and the width may not vary by more than 2mm. The projection of the centreboard when fully down, below keelband, shall be not more than 610mm. With the centreboard in the normal sailing position the leading edge shall slope by not more than 1 in 20 from perpendicular to the baseline.

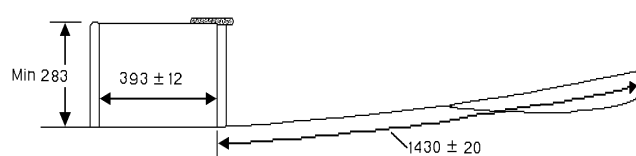

1.4.12 The outer gunwales shall be 15mm ± 3mm in width measured perpendicular to the side panels. The depth of the outer gunwales measured from the sheerline parallel to the side panels shall be 28mm ± 3mm except within 500mm of the bow where the depth may be reduced to not less than 20mm. The radius of the gunwale edges of wooden gunwales shall be not more than 15mm. The minimum dimensions in this rule shall not apply to GRP gunwales.

1.4.13 The stem post shall be not less than 200mm long and not less than 15mm thick.

1.4.14 Holes shall be through the aft transom as follows:-

Two drain holes above the aft deck each of which shall be capable of being contained within a rectangle not more than 40mm in height and not more than 100mm in width. Drain holes may be omitted for GRP boats.

One hole of not more than 18mm diameter for the attachment of the mainsheet, no part of which shall be more than 50mm below the top edge of the transom. The distance between the centres of the mainsheet attachment points on the transom shall be not less than 450mm.

1.4.15 There shall be no holes passing through the hull shell other than for the centreboard, the transom drain holes, mainsheet hole, suction bailers and fixings.

1.5 **Outside Hull Fittings**

1.5.1 A keel-band of non-ferrous metal, D-shaped in cross section and $3\text{mm} \pm 1\text{mm}$ deep on its centreline and not less than 11 wide, shall be fitted to the outside of the hull:

- (i) From a point on the bow transom not less than 20mm from the Forward Measurement Point along the hull centreline to the forward end of the centreboard slot;
- (ii) On each side of the centreboard slot with the inner edges of the band not more than 25mm from the hull centreline;
- (iii) From the aft end of the centreboard slot, along the hull centreline and along the underside and aft edge of the skeg to within 10mm of the Hull Datum Point.

1.5.2 Two rudder pivot fittings shall be fitted on the aft transom the bearing surfaces of which shall be not less than 200mm apart. One rudder retaining device shall be fitted.

1.5.3 A towing eye may be fitted to the stem post or bow transom.

1.5.4 Not more than two suction bailers may be fitted.

1.5.5 Backing plates may be fitted for the shroud attachments. Backing plates of wood or other materials are permitted provided that they are used solely to improve the security and or strength of the fittings mounted on them. They may be placed either inside or outside the wooden panels but they may not be mounted on the outside of the hull, except where this is specifically provided in the rules.

1.5.6 No other fittings shall be fitted to the outside of the hull forward of the aft face of the aft transom.

1.6 **Internal Details**

1.6.1 The length overall measured from the aft face of the aft transom at sheerline to the foremost face of the rubbing strake shall be $3305\text{mm} \pm 20\text{mm}$.

1.6.2 The forward face of the aft bulkhead shall be $425\text{mm} \pm 30\text{mm}$ from the forward face of the aft transom unit measured along the centreline at deck level.

1.6.3 The aft face of the stowage compartment bulkhead shall be $2100\text{mm} \pm 15\text{mm}$ from the forward face of the aft transom unit measured along the centreline at deck level.

- 1.6.4 The aft face of the forward bulkhead shall be $320\text{mm} \pm 20\text{mm}$ forward of the aft face of the stowage compartment bulkhead.
- 1.6.5 The distance between the faces of the side tank panels at the aft face of the stowage compartment bulkhead and at the forward face of the aft bulkhead shall be $750\text{mm} \pm 15\text{mm}$.
- 1.6.6 The depth of the side tank panels shall be $215\text{mm} \pm 15\text{mm}$ at the forward face of the aft bulkhead and $275\text{mm} \pm 15\text{mm}$ at the aft face of the stowage compartment bulkhead.
- 1.6.7 The deck level at all sections shall be $115\text{mm} \pm 15\text{mm}$ below the sheerline.
- 1.6.8 The thwart shall be not less than 142mm in fore and aft width and not less than 13mm nor more than 17mm thick. The thickness dimension shall not apply to GRP thwarts. The thwart shall extend the full width between each side tank panel over and permanently fixed to the top of the centreboard case. A slot on the hull centreline of not more than 19mm in width shall be cut into the thwart. The distance from the aft edge of the thwart to the forward face of the aft transom unit at deck level shall be $1340\text{mm} \pm 25\text{mm}$. The transverse width of the thwart shall be $820\text{mm} \pm 15\text{mm}$.
- 1.6.9 An inspection hatch of $150\text{mm} \pm 20\text{mm}$ in internal diameter shall be fitted to the forward buoyancy tank in either the foredeck or forward bulkhead. The aft bulkhead and the side tank panels may each have one inspection hatch of not more than 170mm in diameter. All inspection hatches shall be fitted with a watertight cover while racing.
- 1.6.10 There shall be one drain hole of diameter $15\text{mm} \pm 5\text{mm}$ in the aft bulkhead and each side tank panel and two drain holes of diameter $15\text{mm} \pm 5\text{mm}$ in the forward bulkhead and the stowage compartment bulkhead. All drain holes other than those in the stowage compartment bulkhead shall be closed while racing.
- 1.6.11 The inner gunwales shall be $20\text{mm} \pm 3\text{mm}$ in width measured perpendicular to the side panels. The depth of the inner gunwales measured from sheerline parallel to the side panels shall be $28\text{mm} \pm 3\text{mm}$ except for within 500mm of the bow where the depth may be reduced to not less than 20mm. The radius of the gunwale edges shall be not more than 15mm. The minimum dimensions in this rule shall not apply to GRP gunwales.
- 1.6.12 The floor battens shall each be $1625\text{mm} \pm 10\text{mm}$ long. They shall be fixed to the cockpit well floor with two either side of the hull centreline. A third pair of battens, with dimensions no greater than those of the others, may be fitted, one on each side of the hull centreline. Battens shall be placed between the aft and the stowage bulkheads. Boats with sail numbers less than 68,000 may have shorter battens. Floor battens may be omitted on GRP boats.
- 1.6.13 The material of the mast step is optional. The top surface of the mast step shall be no more than 12mm above the top surface of the foredeck butt strap. The centre of the mast step shall be $2160\text{mm} \pm 15\text{mm}$ forward of the forward face of the aft transom at deck level. A drain hole not exceeding 6mm diameter is permitted in the mast step. An optional second mast step may be fitted outside of the above tolerances but shall not be used while racing.
- 1.6.14 The centrelines of the shroud blocks shall be $1823\text{mm} \pm 15\text{mm}$ forward of the aft face of the aft transom measured parallel to the centreline. Optional second shroud attachment points may be fitted outside of the above tolerances but shall not be used while racing.
- 1.6.15 The aft transom above deck level shall be $25\text{mm} \pm 3\text{mm}$ thick.

1.6.16 There shall be no holes through the internal structures and decking other than for fixings, except for the footrest which may have one drainhole and the mast step which may have a drainhole of not more than 6mm diameter in the aft edge. The footrest may be omitted on GRP boats.

1.6.17 A bulkhead or strut of plywood or wood may be fitted in each side tank in the vicinity of the thwart.

1.6.18 On GRP boats the material of the drip rail is optional.

1.7 **Internal Fittings**

1.7.1 The shroud attachment fittings shall be permanently fixed to the inside faces of the shroud blocks within ± 10 mm of the centreline of the shroud blocks.

1.7.2 The forestay attachment fitting shall be permanently fixed to the centreline on the inside face of the bow transom above deck level.

1.7.3 There shall be not more than one port and one starboard jib sheet fairlead the position of which shall not be adjustable. Roller fairleads are not permitted. Jib sheet jam cleats may be fitted. The fairleads and associated jam cleats shall be fitted either on the gunwales, the top of the decking or the top of the thwart. If mounting blocks are used they shall be not more than 25mm thick nor more than 150mm in length or breadth and shall not overhang the deck edge or thwart. If backing plates are used, the size is optional, but they shall only be used for their intended purpose.

1.7.4 The tack of the jib may be secured so that it can be adjusted while racing provided that no mechanical advantage is gained by the adjustment

1.7.5 The tack of the Jib may be secured so that it can be adjusted while racing provided that no mechanical advantage is gained by the adjustment.

1.7.6 Other internal fittings are optional subject to any further limitations or prohibitions within these rules.

1.8 **Weight**

1.8.1 Boats shall be weighed with the internal and external surfaces in a dry condition. The initial weighing shall be done before the boat is launched for the first time or after the boat has been kept out of the water in a dry condition with drain holes and hatch covers removed for at least 14 days.

1.8.2 The weight of the hull including correctors, if fitted, shall be not less than 45.5kg. This weight includes all essential fixed fittings which are normally those screwed, glued or bolted in place but excluding centreboard, rudder, tiller, sails, spars, compasses and all other removable and non-essential items.

1.8.3 Corrector weights may be fitted and shall be lead fixed to the underside of the thwart. Corrector weights shall be permanently marked with their weight in Arabic numerals of not less than 15mm in height. The total weight of the correctors for boats first certificated after the 1st September 1997 shall not be more than 3kg. The number of and weight of each corrector weight, if fitted, shall be recorded on the measurement certificate.

1.8.4 Corrector weights shall not be moved or altered unless the boat is re-weighed in a dry condition by an approved measurer who shall record the revised weight on the Measurement Certificate and sign it. The certificate shall be sent to the National Authority or National Mirror Class Association, which shall endorse the certificate and return it to the owner.

2. CENTREBOARD

2.1 The centreboard shall be of solid or laminated wood. The material of finishes is optional, and it may be sheathed with GRP, but shall not be otherwise reinforced. When a centreboard is sheathed it must still be capable of floating unaided in fresh water.

2.2 The centreboard shall conform with the diagram. The centreboard shall be not more than 14mm thick and the thickness shall not vary by more than 1mm to within 50mm of its edges with the exception of hollows or cavities of not more than 2mm in dimension. The leading, trailing and bottom edges of the centreboard shall be within 5mm of a straight line and the leading and trailing edges shall be parallel within a tolerance of 10mm. Brass or other metal protection strips are not allowed.

2.3 A handle of tape or rope may be fitted.

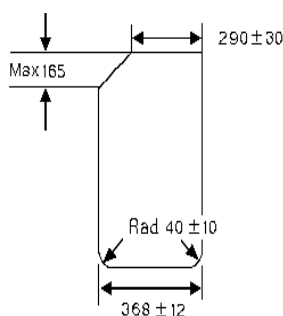

3. RUDDER

3.1 The rudder blade and stock shall be of solid or laminated wood. The material of the finishes is optional, but they shall not be reinforced. The only holes allowed in the rudder stock are the rudder blade pivot bolt and fixings.

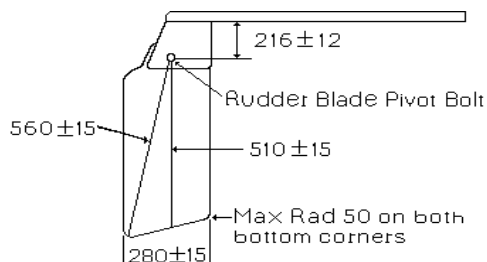

3.2 The dimensions of the rudder shall conform with the diagram. The rudder shall be not more than 14mm thick and the thickness shall not vary by more than 1mm to within 25mm of its edges with the exception of hollows or cavities of not more than 2mm in dimension and holes for fixing.

3.3 The material of the tiller and method of fixing to the rudder are optional.

- 3.4 The rudder blade shall be able to rotate around the pivot, but the leading edge shall not be able to be moved forward of a line parallel to the transom centreline.
- 3.5 The fitting of washers between the rudder blade and the rudder stock is permitted.

4. BUOYANCY TEST & INSPECTION

- 4.1 Buoyancy tanks shall be formed by the decking, the bulkheads, the side tank panels and the hull shell.
- 4.2 Each buoyancy tank shall be individually tested and inspected in accordance with Administrative rule 6.1(i) using the following procedure:

The buoyancy tank hatches shall be closed normally and draining holes shall be closed with their normal stoppers except where tubes to a pressure source and gauge are connected. Equipment for producing a pressure differential between the buoyancy tank and the surrounding atmosphere and a U-tube water gauge for measuring the differential shall then be connected to the tank. Air pressure shall be applied to the tank sufficient to produce a differential reading of at least 100mm on the water gauge. After isolating the buoyancy tank from the pressure source, the pressure differential shall not decrease from 100mm to 50mm in less than 20 seconds.

After completing the tests and carefully checking that the condition and fastenings of all the buoyancy tanks are sound the measurer or Club Officer may, at his discretion, sign the buoyancy endorsement on the Measurement Form or Certificate.

5. SPARS

5.1 Mast

- 5.1.1 The overall length of the mast, including end fittings, if fitted, shall be not more than 3296mm.
- 5.1.2 The mast may be of solid unlaminated wood or aluminium alloy tube with wood end plugs.
- 5.1.3 The mast shall be circular in cross section between a point 50mm from the bottom end and a point 130mm from the top end, except that hollows or cavities not more than 2mm deep shall not be considered an infringing of this rule.
- 5.1.4 The diameter of a wood mast shall be 50mm \pm 6mm and the diameter of an aluminium alloy mast shall be 50mm \pm 3mm.
- 5.1.5 The mainsail halyard sheave shall be contained entirely within a slot cut in the centre of the mast and the distance between the bottom of the mast and the bearing surface of the sheave shall be not more than 3200mm.
- 5.1.6 The distance between the bottom end of the mast and the top edge of the boom shall be 669mm \pm 10mm.
- 5.1.7 The weight of the mast including fixed fittings shall be not less than 2.7kgs.
- 5.1.8 The aft side of the mast shall be straight. A permanent set of not more than 15mm shall not be considered to infringe this rule.

- 5.1.9 The peg on the bottom of the mast shall be on the centre line of the mast and it shall not be possible for the peg to move in the mast step by more than 2mm in any direction when the mast is raised
- 5.1.10 The spinnaker pole fitting shall project not more than 35mm.
- 5.1.11 Rigging may not be run inside the mast.

5.2 **Main Boom**

- 5.2.1 The overall length of the boom, excluding fittings, shall be 2260mm ± 25mm.
- 5.2.2 The boom shall be of solid unlaminated wood.
- 5.2.3 Except within 100mm of its forward end the boom shall be of constant section of 40mm ± 3mm depth and 40mm ± 3mm width.
- 5.2.4 The distance from the inner end of the boom to the opposite side of the kicking strap block shall be not less than 483mm.
- 5.2.5 No fitting shall be attached to the side of the boom aft of the kicking strap block.
- 5.2.6 A clew outhaul track may be recessed flush to the top of the boom.

5.3 **Gaff**

- 5.3.1 The overall length of the gaff measured along the luff groove shall be not more than 2809mm.
- 5.3.2 The gaff shall be solid wood or laminated from two (paired) pieces of wood.
- 5.3.3 The circumference (girth) of the gaff shall be not less than:

at the top end	102mm
at the point 204mm from the lower end, measured along the luff groove	127mm
at the gaff band	146mm

The gaff shall be uniformly tapered from the gaff band to the peak. No section of the gaff shall exceed 45mm in the fore and aft or the thwartships directions except over the cheeks of the jaws.

- 5.3.4 The luff groove face of the gaff shall be straight. A permanent set of 15mm shall not be considered to infringe this rule.
- 5.3.5 A distinctive coloured measurement band of not less than 16mm in width shall be painted on the gaff so that the lower edge of the band is not less than 76mm from the top of the gaff.
- 5.3.6 The mainsail halyard shall be attached to the gaff by an attachment band or by an attachment pin through a slot in the gaff. The bottom of the mainsail halyard attachment band or pin shall be not more than 1733mm below the top of the gaff.

5.3.7 Hollows in the gaff in way of the mast are not permitted.

5.4 **Spinnaker pole and Jib Stick**

5.4.1 The overall length of the spinnaker pole and jib stick, including end fittings, if any, shall each be not more than 1524mm. The cross section dimensions and fittings are optional.

5.4.2 The spinnaker pole and jib stick if carried, shall be of wood or aluminium tube.

6. **RIGGING**

6.1 **Standing Rigging**

6.1.1 Only the following standing rigging of wire rope not less than 2mm diameter shall be fitted:

One forestay	
Two shrouds	} A plastic or GRP cap
One jib halyard strop	} to protect mast from rigging is permitted

6.1.2 All standing rigging shall be attached to the mast by being looped over the top of the mast not more than 50mm from its top.

6.1.3 The forestay shall be attached to the forestay attachment fitting. The method of attachment is optional.

6.1.4 Each shroud shall be attached to a shroud attachment fitting. The method of attachment is optional but Highfield levers are not permitted.

6.1.5 The shroud tension and the length of the shrouds and forestay shall not be altered while racing.

6.2 **Running Rigging**

6.2.1 The type and material of running rigging and associated fittings are optional subject to the following limitations:

- (i) Main and jib halyards must be made fast on the mast below the gooseneck. The main halyard may be tightened using a 2:1 purchase. No other mechanical advantage may be used to tighten either halyard.
- (ii) The main sheeting arrangement shall have only two single turning blocks, one on the boom and the other on the transom. Strops not longer than 60mm may be used. The mainsheet shall not be cleated.
- (iii) There shall be no ratchet blocks, other than for the mainsheet which may have one ratchet block.
- (iv) The kicking strap shall have a purchase not greater than 4:1.
- (v) Other apparatus which controls mast bend is prohibited.
- (vi) The kicking strap (vang) and the mainsail tack down haul may be lead to the thwart or side tank.

7. SAILS

7.1 General

7.1.1 Sails shall conform with the class rules and the ISAF Equipment Rules of Sailing 1997-2000 (ER).

Measurements shall be taken according to the ER unless otherwise specified. Where a term is used in its **defined** sense, it is printed in "italic" type if defined in the ISAF Racing Rules of Sailing (RRS) and in "**bold**" type if defined in the ER.

7.1.2 The manufacturer of sails is optional.

7.1.3 The **seams** of each sail shall be approximately parallel. Broadseaming and additional seams for the foot panels are permitted.

7.2 Mainsail

7.2.1 **Construction**

7.2.1.1 The construction shall be: **Soft sail, single ply sail.**

7.2.1.2 The **body of the mainsail** shall consist only of **woven ply** made from polyester. **Reinforcements** shall be of materials permitted in the **body of the sail.**

7.2.1.3 The colour of the **ply** shall be red within the range of Pantone Warm Red and its derivatives 179, 185, 187, 192, 193, 200 and 201, of the Pantone Colour Formula Guide 747XR. White luff tapes extending not more than 30mm from luff are permitted.

7.2.1.4 The sail shall have 3 **batten pockets** in the **leech**. The centrelines of each batten pocket shall be within +/- 50mm of the **half, quarter and three quarter leech points.**

7.2.1.5 The sail shall have a bolt rope for the minimum length of 2810mm from the **head** along the **luff.**

7.2.1.6 The following are permitted: Stitching, glues, webbing, woven tapes, bolt ropes on the **luff**, corner eyes, **luff** lacing eyes, batten pocket elastic, batten pocket end caps, batten retaining devices, **sailmakers labels** as permitted by the RRS, sail numbers, national letters, class insignia and tell tails.

7.2.1.7 The shape of the **foot** shall be convex.

7.2.1.8 The luff measurement point (LMP) is the point on the luff 1245mm from the **tack point.**

7.2.1.9 There shall be not more than 6 or less than 4 luff lacing eyes below the LMP.

7.2.1 Dimensions

	Minimum	Maximum
Leech length		4520mm
Head width		55mm
Luff length		4052mm
Foot length		2135mm
Foot median		4340mm

Half leech point to the LMP		1650mm
The diagonal taken from the LMP to the tack point		2530mm
Upper width at 1067mm from head point		725mm
Primary reinforcement from corner measurement point		271mm
Secondary reinforcement from corner measurement point		813mm
for flutter patches		100mm
for chafing patches		750mm
for batten pocket patches		150mm
Inside batten pocket length :		
Uppermost batten pocket		560mm
Middle batten pocket		660mm
Lowermost batten pocket		660mm
Inside batten pocket width	32mm	60mm

7.3 Headsail

7.3.1 Construction

7.3.1.1 The construction of the sail shall be: **Soft sail, single ply sail.**

7.3.1.2 The **body of the sail** shall consist only of **woven ply** made from Polyester. Reinforcement shall be of materials permitted in the **body of the sail.**

7.3.1.3 The colour of the **ply** shall be red within the range of Pantone Warm Red and its derivatives 179, 185, 187, 192, 193, 200 and 201, of the Pantone Colour Formula Guide 747XR. White luff tapes extending not more than 30mm from the luff are permitted.

7.3.1.4 The following are permitted: Stitching, glues, webbing, woven tapes, corner eyes, hanks and associated eyes, one window, **sailmakers labels** as permitted by RRS and tell tales.

7.3.1.5 The **leech** shall not be convex.

7.3.2 Dimensions (to be measured as a **headsail**)

	Minimum	Maximum
Luff length		2782mm
Leech length		2442mm
Foot length		1540mm
Foot median		2545mm
Top width		35mm
Primary reinforcement		234mm
Secondary reinforcements		702mm
from corner measurement points		
for flutter patches		100mm
for chafing patches		750mm
Window in any direction		460mm
Shortest distance from window to edge of sail	125mm	

7.4 **Spinnaker**

7.4.1 **Construction**

7.4.1.1 The construction shall be: **Soft sail, single ply sail.**

7.4.1.2 The **body of the sail** shall consist only of **woven ply** made from nylon. Primary Reinforcements shall be of woven ply polyester. Secondary Reinforcements shall be made from materials permitted in the **body of the sail.**

7.4.1.3 The following are permitted. Stitching, glues, webbing, woven tapes, corner eyes, corner rings, recovery line patches and eyes, **sailmakers labels** as permitted by the RRS and sail numbers.

7.4.1.4 The sail shall be constructed in two halves, then joined by a centre seam. Any seam other than the centre seam shall be straight.

7.4.1.5 The sail may be of any colour or combination of colours.

7.4.1.6 The **leeches** shall be not more than 15mm from a straight line joining the **head to clews** when the sail is folded about the centre seam.

7.4.2 Dimensions (to be measured as a **spinnaker**)

	minimum	maximum
Leech lengths	2700mm	2820mm
Foot median		3490mm
Foot length		2286mm
Quarter width		2550mm
Half width		2220mm
Three quarter width		1190mm
Primary reinforcement		234mm
Secondary reinforcement		
from corner measurement points		702mm
Recovery patches		225mm

7.5 **Class Insignia and Sail Numbers**

7.5.1 The class insignia and the sail numbers, as issued by the ISAF shall be in accordance with RRS Appendix H, except where varied herein.

7.5.2 The class insignia shall conform with the dimensions and requirements as detailed in the diagram contained in part C of these rules. The class insignia shall not be shown on headsails or spinnaker.

7.5.3 The Mainsail and Spinnaker shall carry the full boat/plaque number.

7.5.4 The numbers, letters and insignia on the mainsail shall be black. The insignia may be placed back to back, if placed back to back the points of the insignia shall point towards the **leech.**

7.6 **Additional Sail Rules.**

7.6.1 Not more than 1 mainsail, 1 headsail and 1 spinnaker may be carried on board.

- 7.6.2 Not more than 1 mainsail, 1 headsail and 1 spinnaker shall be used in any one event of less than 14 consecutive days duration.
- 7.6.3 The mainsail shall be set so that the highest visible point at the **head** is lower than the lower edge of the gaff **measurement band**.
- 7.6.4 The mainsail shall be loose footed.
- 7.6.5 Each sail shall be fitted with not more than one attachment point at each **head, tack** and **clew**.
- 7.6.6 **Double luff sails** are prohibited.

8. CREW

Except when otherwise specified in the sailing instructions there shall be two persons on board while racing.

9. PROHIBITIONS

- 9.1 The use of any apparatus or contrivance outboard or extending outboard, of the gunwale the purpose of which is or may be to support or assist in supporting the crew outboard.
- 9.2 Electronic and electrical instruments with the exception of electronic timing devices.

10 ADVERTISING

Advertising rules according to ISAF Category C, with the following limitations -

- 10.1 No advertising on jib.
- 10.2 Advertising on mainsail is limited to the bottom 500mm.
- 10.3 Advertising on spinnaker to be no closer than 150mm to the numbers.
- 10.4 Advertising on the hull is limited to the central 50% of the hull length.

PART C – CLASS INSIGNIA

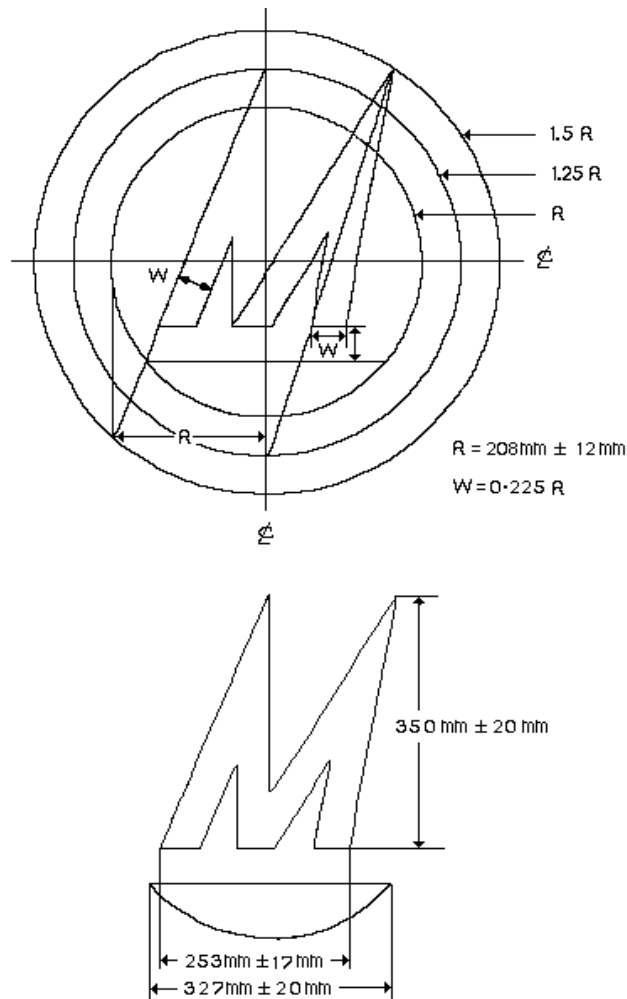

The dimensions are changed to $W=0.225R$ minimum and $0.40R$ maximum.
 Height of M= $350\text{mm} \pm 25\text{mm}$ and the width of Half Moon M= $327 \pm 65\text{mm}$.

© ISAF (UK) Ltd., Southampton, UK

Effective: 1st March 2003
 Previous Issue: 1st March 2000

NOTE For these Rules the ISAF have defined "hull panels" as including the following parts:-

- | | |
|-------------------|-----------------------|
| Aft Bottom Panel | Forward Bottom Panel |
| Aft Topside Panel | Forward Topside Panel |
| Aft Transom Unit | Forward Transom |
| Stowage Bulkhead | Mast Web |
| Forward Bulkhead | Aft Bulkhead |
| Side Tank Side | Forward Deck |
| Side Deck | Aft Deck |
| Skeg | Side Tank Stiffener |